

# ASSP

## FRAM Embedded High-speed RFID LSI

# MB89R112

### ■ DESCRIPTION

The MB89R112 is a vicinity type of RFID LSI device embedded with 9 Kbytes FRAM, which enables fast and frequent write operation.

### ■ FEATURES

- Memory capacity of 9 Kbytes FRAM (including 8192 bytes of user area)
- 32-byte/block configuration, 256 blocks
- High-speed data transmission at 26.48 kbps
- Fast command supported (data transmission at 52.97 kbps) (Transponder → Reader/Writer)
- Carrier frequency at 13.56 MHz
- Anti-collision function : 30 tags per second
- Read/Write endurance :  $10^{12}$  times
- Data retention : 10 years ( + 85 °C ) , 30 years ( + 70 °C )
- 64-bit UID
- FRAM memory data protection
- Transmission protocol based on ISO/IEC 15693, ISO/IEC 18000-3 (Mode 1) (\*)

\* : Refer to "■ USAGE NOTES".

## ■ BLOCK DIAGRAM

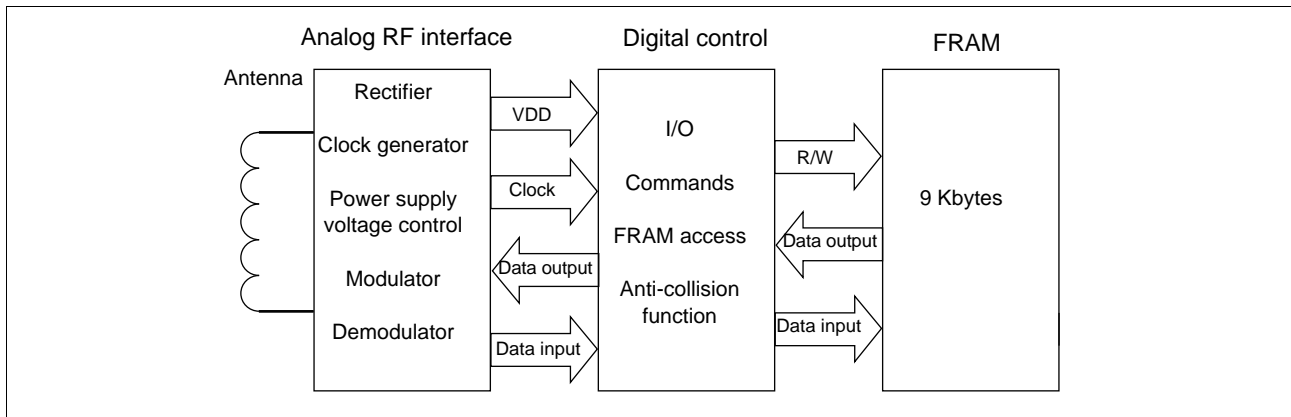

## ■ MEMORY

### 1. Memory Map

This section describes the FRAM memory, which is the internal memory of the MB89R112.

- FRAM Configuration

The FRAM has 8192 bytes for use as user area and 1024 bytes for use as system area.

The user areas consist of 256 blocks. Each block can store 256 bits (32 bytes) of data.

The block is the unit used for the writing and reading of FRAM data. The memory configuration of FRAM is shown below.

- FRAM memory configuration

Area	Block Number (RF)	Details	Data read	Data write
User area (8192 bytes)	00 <sub>H</sub> to FF <sub>H</sub> (1block = 256bit)	User area	Yes	Yes
System area (1024 bytes)	100 <sub>H</sub>	BBS (Block Security Status)	Yes	No
	101 <sub>H</sub>	RLS (Read Lock Status)	Yes	No
	11E <sub>H</sub>	AFI,DSFID,UID	Yes	Limited

# MB89R112

## ■ DATA ELEMENT DEFINITION

### 1. Unique Identifier (UID)

The MB89R112 has a 64-bit unique identifier (UID). The UID is used to distinguish a transponder from another transponder in the anti-collision algorithm described later.

The UID consists of the 3 items shown in the following.

- An 8-bit data whose value is always "E0<sub>H</sub>" (bit 57 to bit 64)
- An 8-bit IC manufacturer code whose value is always "08<sub>H</sub>", and is defined by ISO/IEC 7816-6/AMI (bit 49 to bit 56)
- Unique 48-bit serial number assigned by FUJITSU SEMICONDUCTOR (bit 1 to bit 48)

Among the unique 48-bit serial number assigned by FUJITSU SEMICONDUCTOR, the 1 byte from bit 41 to bit 48 defines MB89R112 code whose value is "05<sub>H</sub>". And the 5 bytes from bit 1 to bit 40 define other serial number.

#### • Structure of UID

MSB				LSB			
64	57	56	49	48	41	40	1
"E0 <sub>H</sub> "		IC manufacturer code "08 <sub>H</sub> "		"05 <sub>H</sub> "		other serial number	
Unique serial number assigned by FUJITSU SEMICONDUCTOR							

## 2. Application Family Identifier (AFI)

The application family identifier (AFI) identifies the type of application set by the transponder. The AFI can be written with a command. The AFI is 8-bit data and is stored in the system area of FRAM. The factory default setting of the AFI is "00<sub>H</sub>".

### • Types of AFI

Application Family (bit 8 to bit 5)	Application Sub-Family (bit 4 to bit 1)	Application Use Field	Example/Note
"0"	"0"	All families and sub-families	No applicative preselection
X	"0"	All sub-families of family X	Wide applicative preselection
X	Y	Only the Yth sub-families of family X	—
"0"	Y	All families of Yth sub-families	—
"1"	"0", Y	Transport	Mass transit, bus, airline
"2"	"0", Y	Financial	IEP, banking, retail
"3"	"0", Y	Identification	Access control
"4"	"0", Y	Telecommunication	Public telephone, GSM
"5"	"0", Y	Medical	—
"6"	"0", Y	Multimedia	Internet services
"7"	"0", Y	Gaming	—
"8"	"0", Y	Data storage	Portable files
"9"	"0", Y	EAN-UCC system for application identifiers	Managed by ISO/IEC JTC 1/SC 31
"A"	"0", Y	ISO/IEC JTC 1/SC 31	Data identifiers as defined in ISO/IEC 15418
"B"	"0", Y	UPU	Managed by ISO/IEC JTC 1/SC31
"C"	"0", Y	IATA	Managed by ISO/IEC JTC 1
"D"	"0", Y	RFU*	Managed by ISO/IEC JTC 1/SC 17
"E"	"0", Y		Managed by ISO/IEC JTC 1/SC 17
"F"	"0", Y		Managed by ISO/IEC JTC 1/SC 17

\* : Reserved for future use

Note : Both X value and Y value are "1" to "F".

In the status of the AFI\_flag setting;

- If the AFI is not supported by the transponder, no response to all requests is returned.
- If the AFI is supported by the transponder, the response is returned only if the value is in accord with the AFI sent from a reader/writer.

## 3. Data Storage Format Identifier (DSFID)

The data storage format identifier (DSFID) indicates how data is structured in the transponder (LSI memory device). The DSFID can be programmed with a command.

The DSFID is 8-bit data and is stored in the system area of FRAM. The factory default setting of the DSFID is "00<sub>H</sub>".

## 4. Cyclic Redundancy Check (CRC)

When a frame is received, reception of correct data making up the frame is assumed only when the value of the cyclic redundancy check (CRC) code is valid. For error-checking purposes, a 2-byte CRC code value is inserted between data and the EOF signal.

The value of CRC code is required from all the data contained between the SOF and CRC field in each frame. Method of calculation is provided in ISO/IEC 13239. The details are provided in ISO/IEC 15693-3 and ISO/IEC 18000-3 (Mode 1) . The initial value of the CRC code provided in ISO/IEC 15693-3 is "FFFF<sub>h</sub>". The CRC code is transferred, beginning with the lowest-order bit in the lowest-order byte.

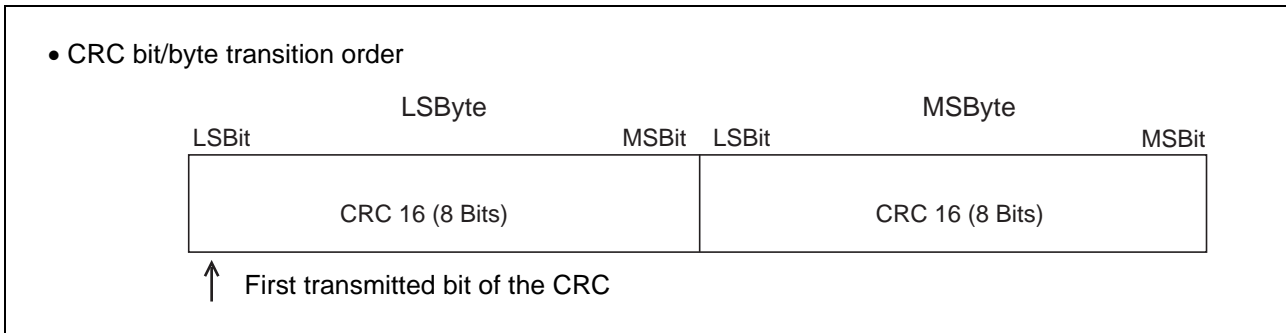

## FUNCTION DESCRIPTION

### 1. Communication from Reader/Writer to Transponder

#### (1) Modulation method

The MB89R112 supports both 10% ASK modulation and 100% ASK modulation.

Modulation index  $m$  is defined as  $m = (a - b)/(a + b)$  with reference to the modulated waveform shown below. The values  $a$  and  $b$  indicate, respectively, the maximum and minimum amplitude of magnetic field transmitted from a reader/writer.

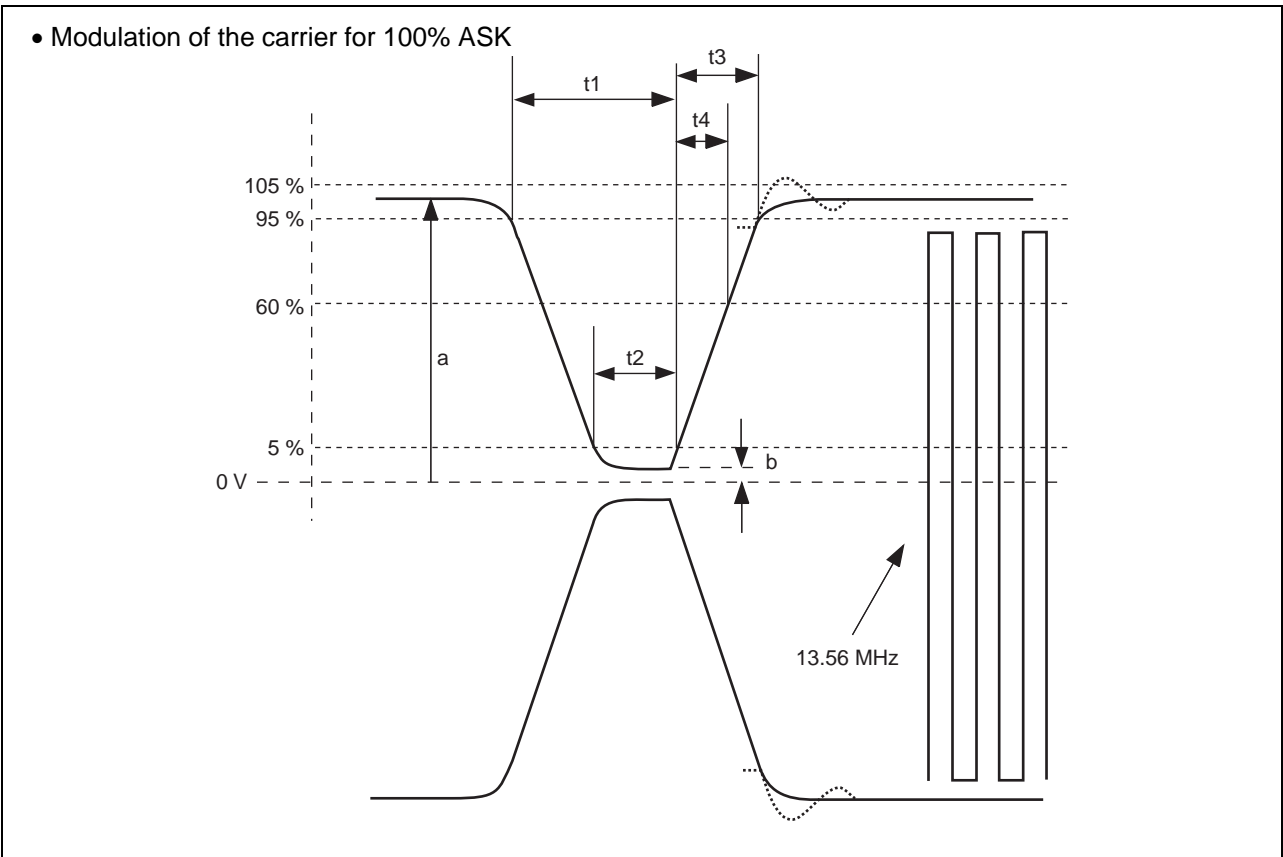
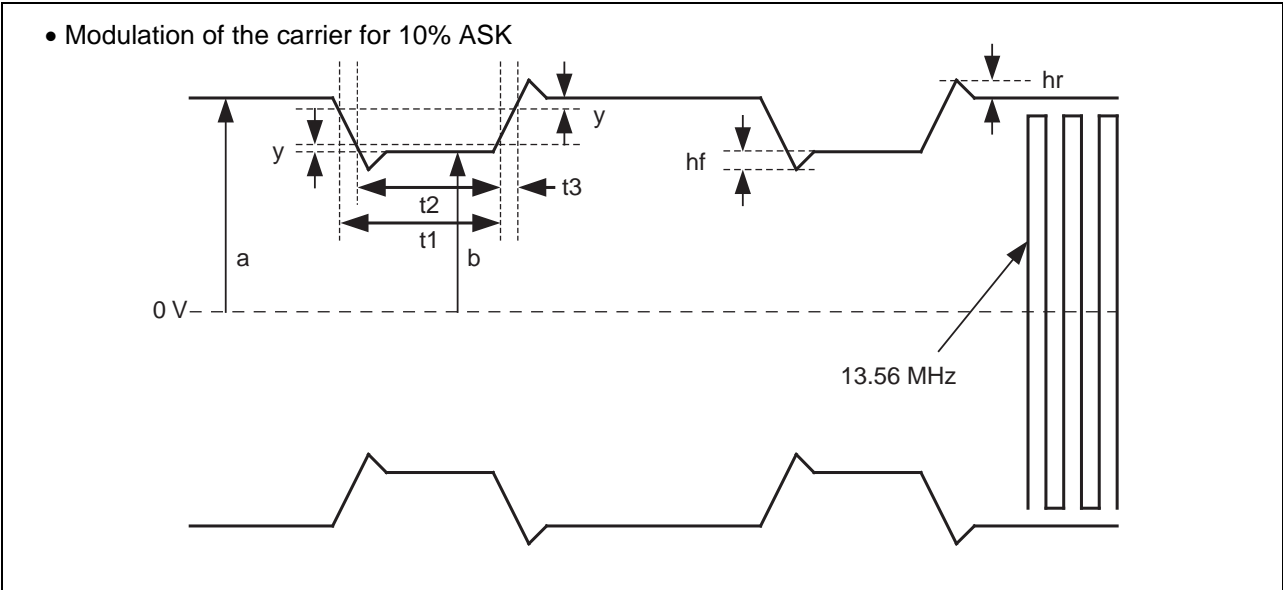

Maximum and minimum values of  $t1$ ,  $t2$ ,  $t3$  and  $t4$  are shown in the table of “ ■ RECOMMENDED OPERATING CONDITIONS”. In this table,  $y$  is  $0.05(a - b)$  and the maximum value of  $hf$  and  $hr$  is  $0.1(a - b)$ .

## (2) Data rate and data coding

The MB89R112 supports only 1 out of 4 mode for bit coding, not 1 out of 256 mode. In 1 out of 4 mode, 2-bit signals are coded in a period of 75.52  $\mu\text{s}$  as shown in the following. When coding takes place, the data rate is 26.48 kbps ( $f_c/512$ ). Each signal is transmitted beginning with the lowest bit.

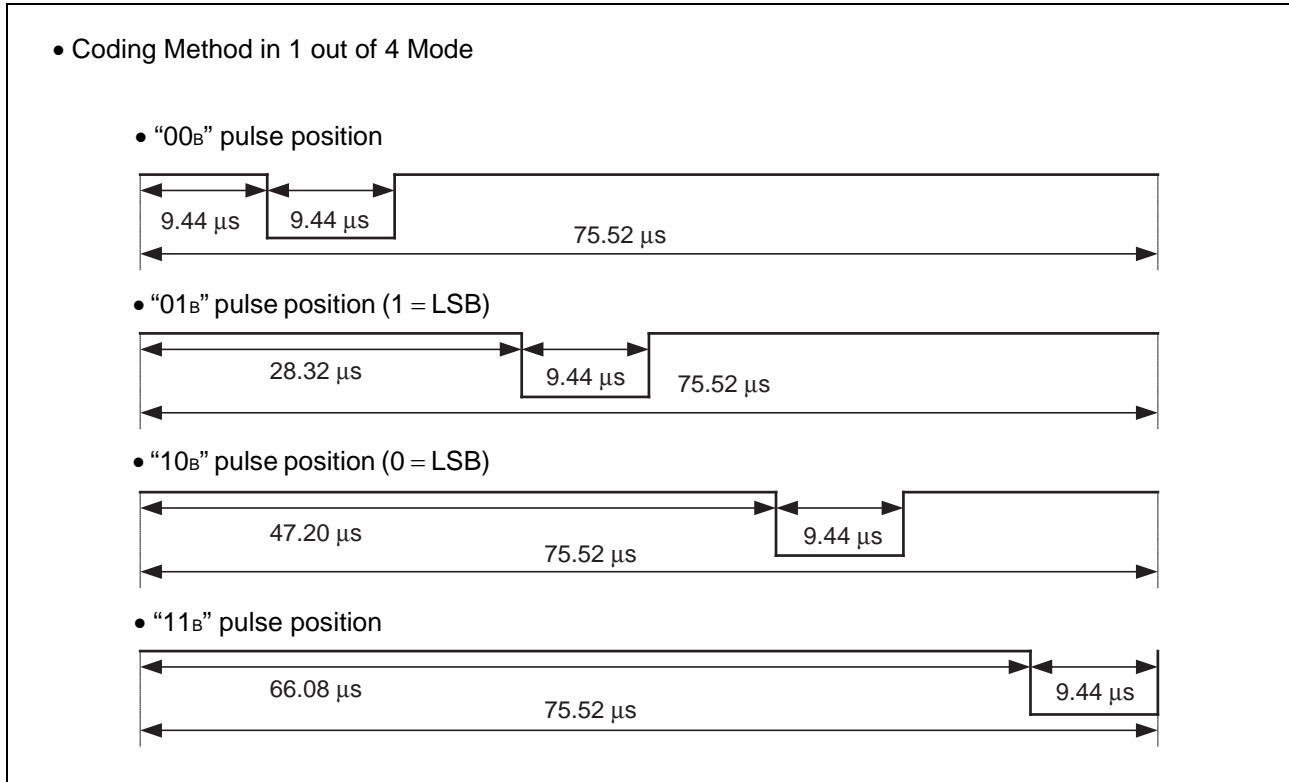

## (3) Data frame

A data frame begins with a start of frame (SOF) signal and ends with an end of frame (EOF) signal. The MB89R112 is enabled to receive a frame from a reader/writer within 300  $\mu\text{s}$  after the MB89R112 has sent a frame to the reader/writer. The MB89R112 is also enabled to receive a frame from a reader/writer within 1 ms after power has been supplied to the MB89R112.

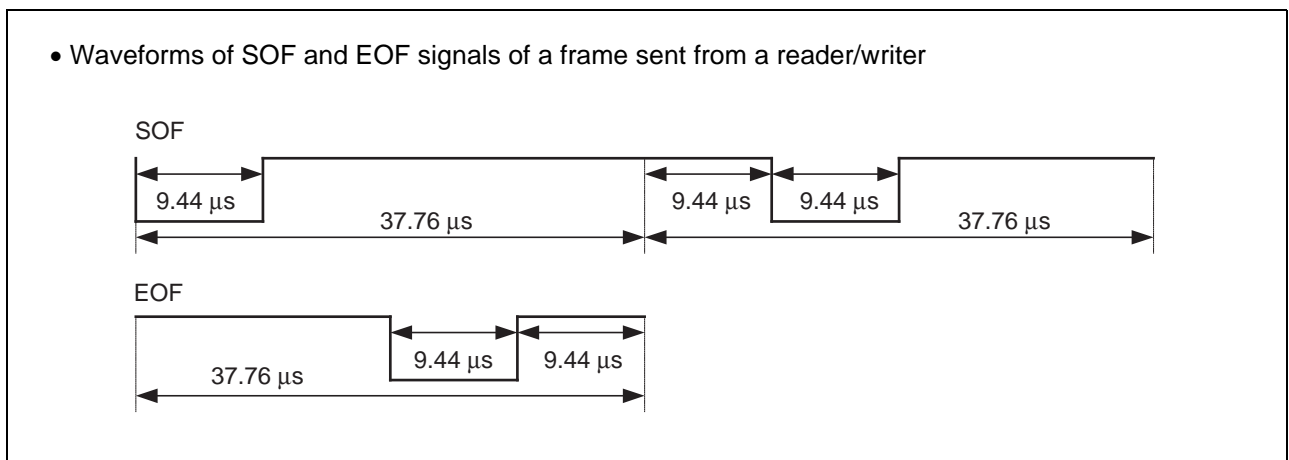



## 2. Communication from Transponder to Reader/Writer

- Minimum load modulation amplitude (V<sub>lm</sub>) : 10 mV (based on ISO/IEC 10373-7)
- Load modulation subcarrier frequency (f<sub>s</sub>) : 423.75 kHz(fc/32)

The MB89R112 supports only 1-subcarrier system.  
(Not the 2-subcarrier system.)

- Data rate : The MB89R112 supports the following 2 data rate modes :
  - Low data rate
  - High data rate

One of the 2 data rate modes is specified by the Data\_rate\_flag (described later) sent from the reader/writer. In low data rate mode, the data rate is 6.62 kbps (fc/2048); in high data rate mode, it is 26.48 kbps (fc/512).

When receiving the Fast commands (Custom commands), the communication starts from the transponder with the data rate that is twice as fast as normal data rate. In this case, the 2 data rate modes of low data rate and high data rate specified by the Data\_rate\_flag is supported. In Low data rate mode, the data rate is 13.24 kbps (fc/1024); in high data rate mode, it is 52.97 kbps (fc/256).

### (1) Bit coding

The Manchester coding is used for the bit coding. The following figures show the signals modulated in high data rate mode when ISO command is received and the same signals when fast command is received. In low data rate mode of both ISO commands and fast commands, the number of pulses for subcarrier and data transfer time are 4 times as large as the number in high data rate mode.

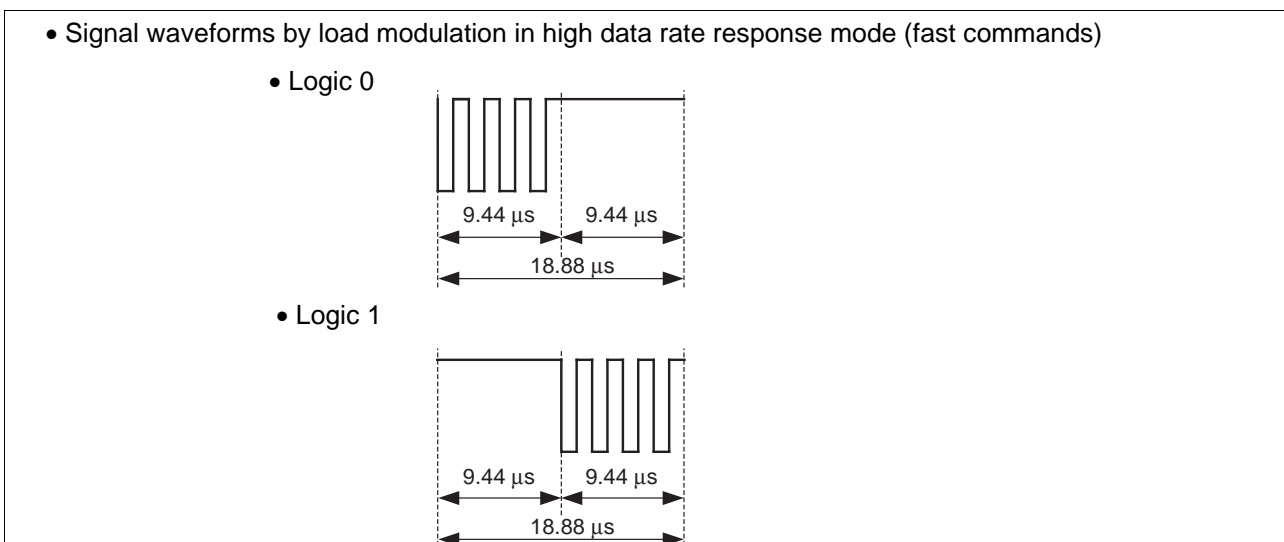
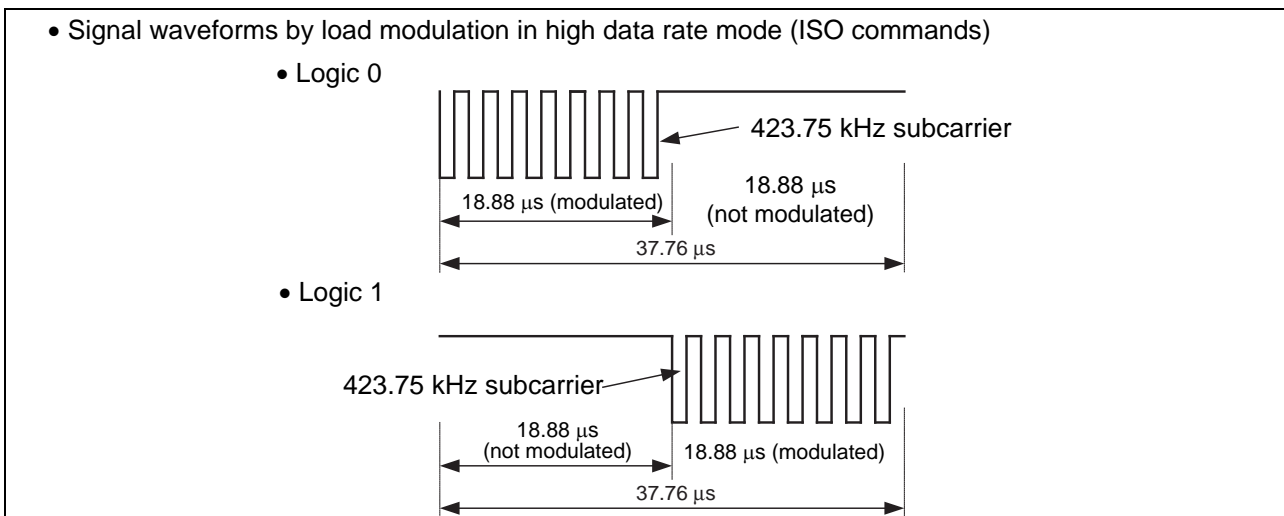

## (2) Data frame

A data frame sent from a transponder starts with a start of frame (SOF) signal and ends with an end of frame (EOF) signal. The following figures show the SOF and EOF signals sent in high data rate mode when an ISO command is received and the same signals when a fast command is received. In low data rate mode of both ISO commands and fast commands, the number of pulses in subcarrier and data transfer time are 4 times as large as the number in high data rate mode. The reader/writer shall be ready to receive a frame from the transponder within 300  $\mu\text{s}$  after having sent a frame to the transponder.

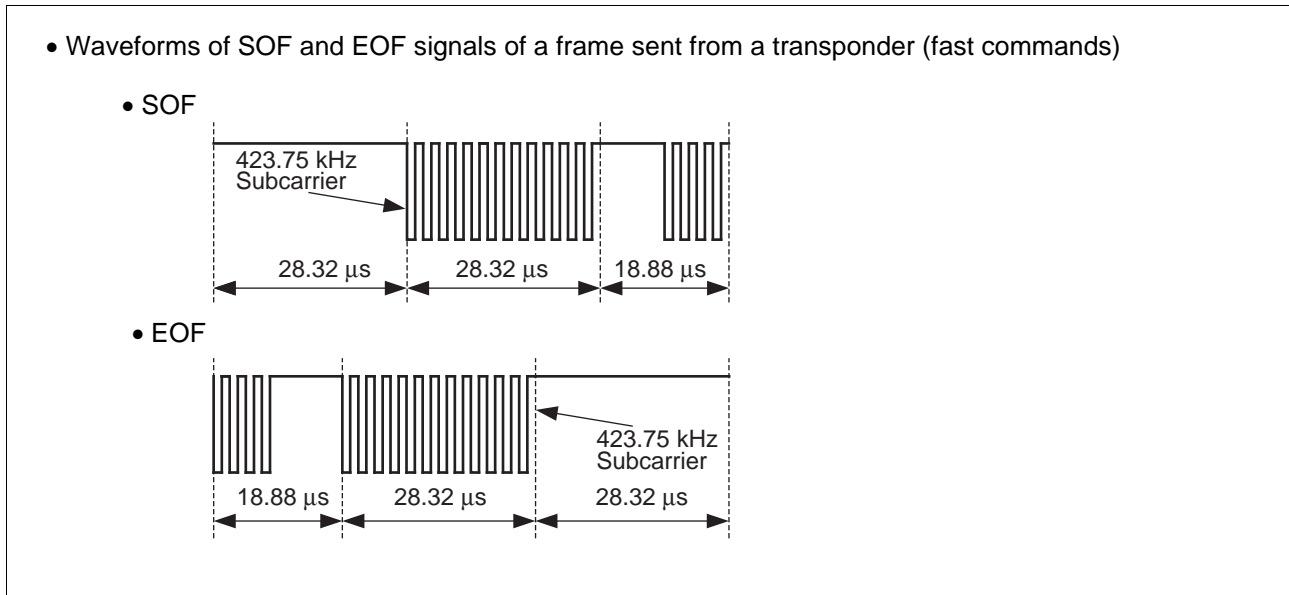
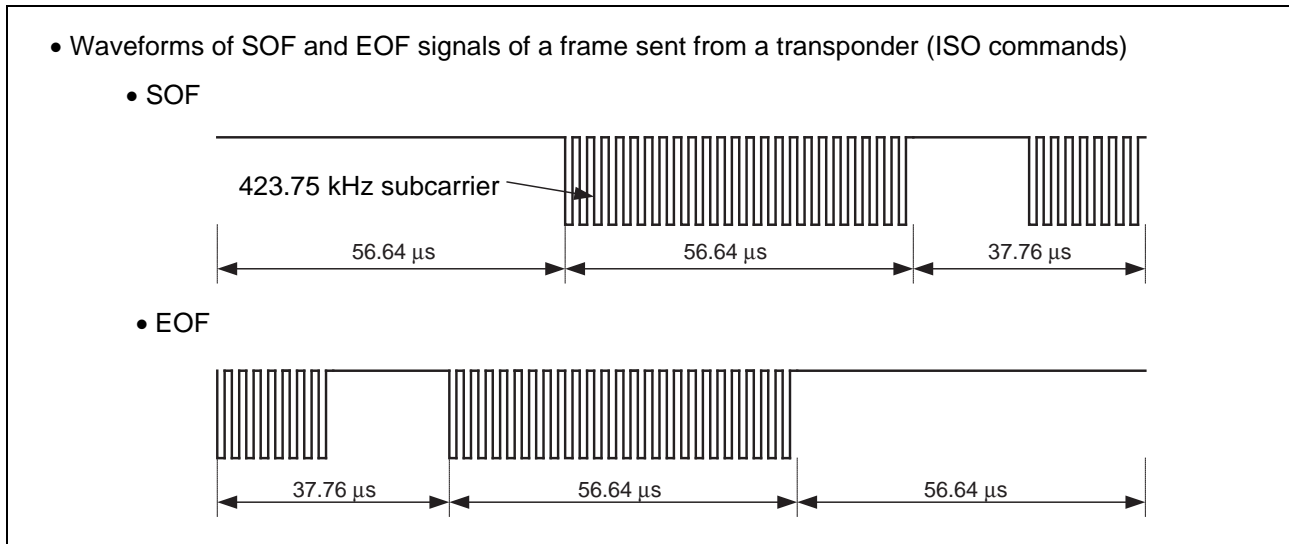

## 3. FRAM Data Protection if Power Lost During Data Writing

MB89R112 accesses to FRAM with the unit of 2 bytes. When RF power is shut down during accessing FRAM, writing in FRAM is completed by the charges stored in a smoothing capacitor on the LSI and FRAM data writing error is prevented.

Therefore, the commands of 1 byte access such as Write AFI, Write DSFID and Lock command are protected from the power down.

On the other hand, the commands of more than 2 bytes access such as Write Single Block command may not protect all the data from the power down during the access. In this case, it is recommended to confirm the data correctness by a read command.

## 4. Requests/Responses

A request is sent from the reader/writer to the transponder. In replying to the request, the transponder sends a response to the reader/writer.

Each request, and response, is transmitted in each single frame.

- Structure of requests and responses

A request consists of the following 5 fields :

- Flag
- Command code
- Parameter (required or optional depending on the command)
- Application data
- CRC

A response consists of the following 4 fields :

- Flag
- Parameter (required or optional depending on the command)
- Application data
- CRC

Each byte is transferred, beginning with the lowest bit. When two or more bytes are transferred, transfer begins with the lowest one.

## 5. Operating Modes

The MB89R112 has the following 3 operating modes :

Each mode specifies a different mechanism for how the transponder returns a response in replying to a request from the reader/writer :

- Addressed mode

The MB89R112 enters Addressed mode when the Address\_flag is set to "1".

In Addressed mode, a request includes a UID (the Address\_flag is set to "1" simultaneously), and only the transponder that matches the UID in the request returns a response. If no transponder that matches the UID exists, a response is not returned.

- Non-Addressed mode

The MB89R112 enters Non-Addressed mode when the Address\_flag is set to "0".

In Non-Addressed mode, a request does not include a UID. The transponders that receive the request execute processing and return its response in accordance with the requested command.

- Select mode

The MB89R112 enters Select mode when the Select\_flag is set to "1", and the Address\_flag is set to "0".

In Select mode, the request shall not contain a UID. When the transponders receive the command, only the transponder in the select state executes processing and returns its response in accordance with the requested command.

## 6. Request Format

The following figure shows a typical example of the request data format, and the following table shows the definition of request flag bits.

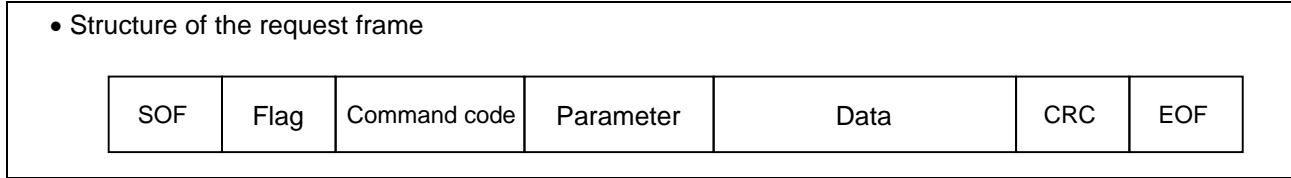

• Setting of Bit 1 to Bit 4

Bit	Flag name	1/0	State/Description
1	Sub-carrier_flag	0	1-subcarrier selected
		1	2-subcarrier selected (not supported)
2	Data_rate_flag	0	Low data rate (6.62 kbps) selected
		1	High data rate (26.48 kbps) selected
3	Inventory_flag	0	Command other than Inventory command selected
		1	Inventory command selected
4	Protocol_Extension_flag	0	Protocol not extended
		1	Protocol extended (RFU*)

\* : Reserved for future use

Note : "Inventory\_flag" of bit 3 is determined whether "Inventory command" (select "1") or other command (select "0") is used.

• Setting of Bit 5 to Bit 8 (When Inventory command is selected [Inventory\_flag = "1"])

Bit	Flag name	1/0	State/Description
5	AFI_flag	0	AFI not set
		1	AFI set (response when it is in accord with AFI of the transponder)
6	Nb_slots_flag	0	16 slots
		1	1 slot
7	Option_flag	0	Command option not supported
		1	Command option supported (not supported)
8	RFU*	0	Set to "0"
		1	—

\* : Reserved for future use

• Setting of Bit 5 to Bit 8 (When the command other than Inventory command is selected [Inventory\_flag = "0"])

Bit	Flag name	1/0	State/Description
5	Select_flag	0	Request shall be executed according to the setting of Address_flag.
		1	Select mode (Request shall be executed only by the transponder in select state.) The Address_flag shall be set to "0".
6	Address_flag	0	Non-Addressed mode (UID not included in the command)
		1	Addressed mode (UID included in the command)
7	Option_flag	0	Command option not supported (for the command not supporting the Option_flag)
		1	Command option supported
8	RFU*	0	Set to "0"
		1	—

\* : Reserved for future use

## 7. Response Format

The following figure shows a typical example of the response data format, and the following table shows the definition of the response flag bits.

If the Error\_flag is set to "1", an error code field is generated in the response. If the Error\_flag is set to "0", this means no error, and If the Error\_flag is set to "1", this means any error generation.

- Structure of the response frame



- Response flag definitions

Bit	Flag name	1/0	Description
1	Error_flag	0	Error not found
		1	Error found
2	RFU*	0	Set to "0"
3	RFU*	0	Set to "0"
4	Extension_flag	0	Set to "0"
5	RFU*	0	Set to "0"
6	RFU*	0	Set to "0"
7	RFU*	0	Set to "0"
8	RFU*	0	Set to "0"

\* : Reserved for future use

- Error code definitions

Error code	Meaning
"01"	The specific command is not supported. Example: Command code error
"02"	Cannot recognize the command. The number of blocks is over the limit. Example: Format error
"03"	Specific options are not supported.
"0F"	Other errors
"10"	The specified block cannot be used (or was not found).
"11"	The specified block has already been locked and cannot be locked again.
"12"	The specified block has already been locked, and its contents cannot be updated.
"13"	The specified block could not be programmed normally (a write verify error occurred).
"14"	The specified block could not be locked normally (a lock verify error occurred) .
Others	Unused.

## 8. Anti-Collision Algorithm

The MB89R112 executes an anti-collision sequence loop based on ISO/IEC 15693.

The Anti-collision algorithm is designed to examine the transponders located within reader/writer communication areas on the basis of UID.

The reader/writer issues an Inventory command to transponders, and some transponders return responses while other transponders do not respond, according to the algorithm described in “10. Execution of Inventory Command by a Transponder”.

## 9. Request Parameter

### • Request Parameter Settings

Set the reader/writer as follows before issuing the Inventory command.

- The Nb\_slots\_flag (bit 6), which is a request flag, is set to the desired value :  
 “0” : 16 slots (for plural transponders)  
 “1” : 1 slot (for single transponder)
- A mask length and a mask value are added after the command code.
- The mask length represents the data length of the mask value in bits.
- The mask value is integer bytes of data, transmitted beginning with the lowest bit. If the mask data is not a multiple of 8 (bits) in length, 0 is padded on the MSB side of the mask value so that the data is in units of bytes.

The following figure shows an example of the mask value with padding. Since the mask length is 12 bits, the mask value is padded with 4 bits on the MSB side so that the mask data is in units of bytes (2 bytes = 16 bits in this case).

If the AFI flag in the request flags is set in the format explained in “• Structure of the request frame of 6. Request Format”, an AFI field is added to the format. The command ends with transmission of an EOF signal as described in “1. Communication from Reader/Writer to Transponder”. Thereafter, processing in the first slot starts immediately. To proceed to the next slot, the reader/writer sends an EOF signal.

### • Format of the Command

SOF	Flag	Command code	Optional AFI	Mask length	Mask value	CRC	EOF
	8 bits	8 bits	8 bits	8 bits	0 to 64 bits	16 bits	

### • Example of the Mask Value with Padding

MSB	LSB
0000	0100 1100 1111
Pad	Mask value

10. Execution of Inventory Command by a Transponder

A transponder returns a response to the reader/writer when its UID is equal to the value that consists of the mask value and the number of slots. The mask value is sent in the Inventory command, and the number of slots is determined by the number of times the EOF signal is transmitted.

- Algorithm for execution of processing by a transponder

The following figure shows the algorithm for the execution of processing by a transponder when an Inventory command is received. The next figure shows the relationship between the UID and the mask value.

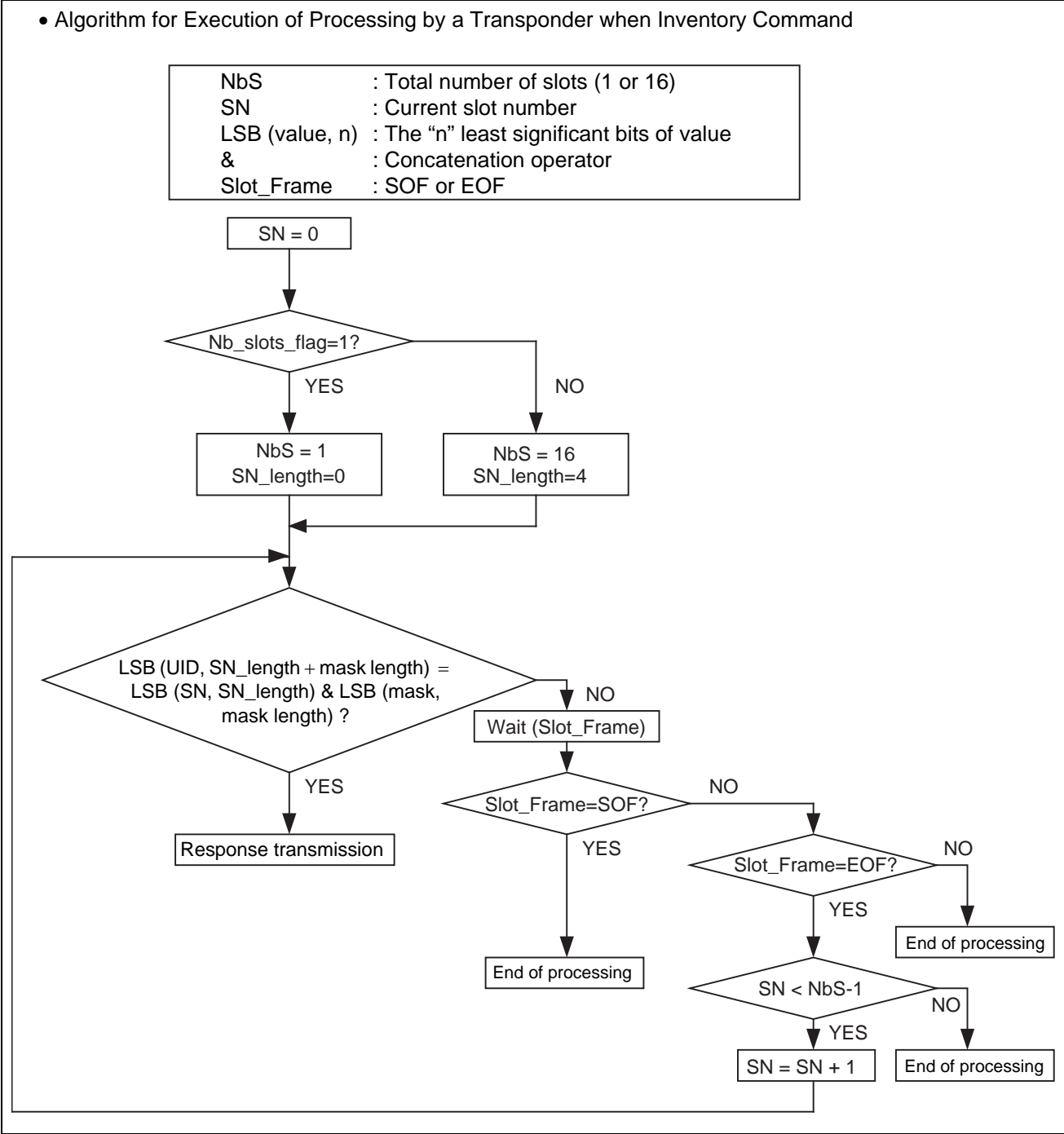

- Comparison of the mask value and the number of slots with the UID

[Inventory command (the side of a reader/writer)]

Inventory command includes the mask value and mask length.  
The mask value is padded with "0" into the higher bit side so to make the byte-unit length (a multiple of 8 bits).

If Inventory command is received, the slot counter is reset to "0".

If EOF is received, the increment of the slot counter is started by the transponder.

The value is compared with the lowest bit in UID of the transponder.  
If the value is in accord with the mask value, the response is returned by the transponder.

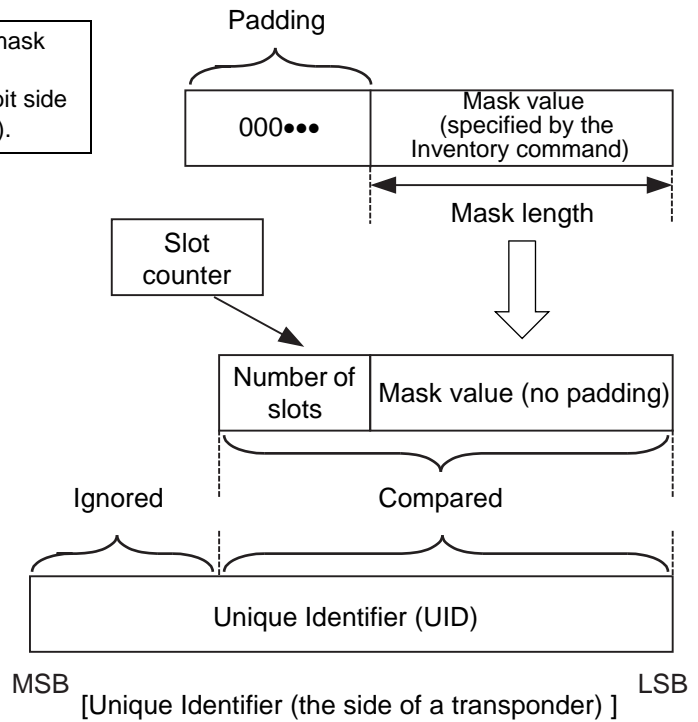



## 11. Anti-Collision Sequence

- Execution of anti-collision sequence

The following steps summarize the main cases that can occur during a typical anti-collision sequence where the number of slots is 16.

- 1) The reader/writer sends an Inventory command.  
The Nb\_slots\_flag bit of the request flags is set to "0" to specify the number of slots.
- 2) In slot 0, transponder 1 transmits its response in the time t1\_a from the detection of the rising edge of the EOF. In this case no collision occurs and the UID of transponder is received and registered by the reader/writer.
- 3) The reader/writer sends an EOF signal to switch to the next slot in the time t2\_a after the response 1.
- 4) In slot 1, transponder 2 and transponder 3 transmit their response in the time t1\_a from the detection of the rising edge of the EOF. In this case, the reader/writer cannot recognize the UIDs of the two transponders because the collision occurs, and the reader/writer remembers that a collision was detected in slot 1.
- 5) The reader/writer sends an EOF signal to switch to the next slot in the time t2\_a after the responses.
- 6) In slot 2, no transponder transmits a response. The reader/writer does not detect any response, and sends an EOF signal to switch to the next slot in the time t3\_a from the detection of the rising edge of the EOF.
- 7) In slot 3, transponder 4 and transponder 5 transmit their response in the time t1\_a from the detection of the rising edge of the EOF, and another collision occurs.
- 8) The reader/writer sends a request (for example, a Read Single Block command, described later) to the transponder 1, which UID was already correctly received.
- 9) All transponders detect an SOF signal and exit the Anti-collision sequence. In this case, since the request is addressed to transponder 1 (Addressed mode), only transponder 1 transmits its response.
- 10) All transponders are ready to receive another request from the reader/writer. If the Inventory command is sent again, the Anti-collision sequence starts from slot 0.

Note : t1\_a, t2\_a, t3\_a are specified in "12. Timing definitions".

# MB89R112

## • Example of Anti-Collision Sequence

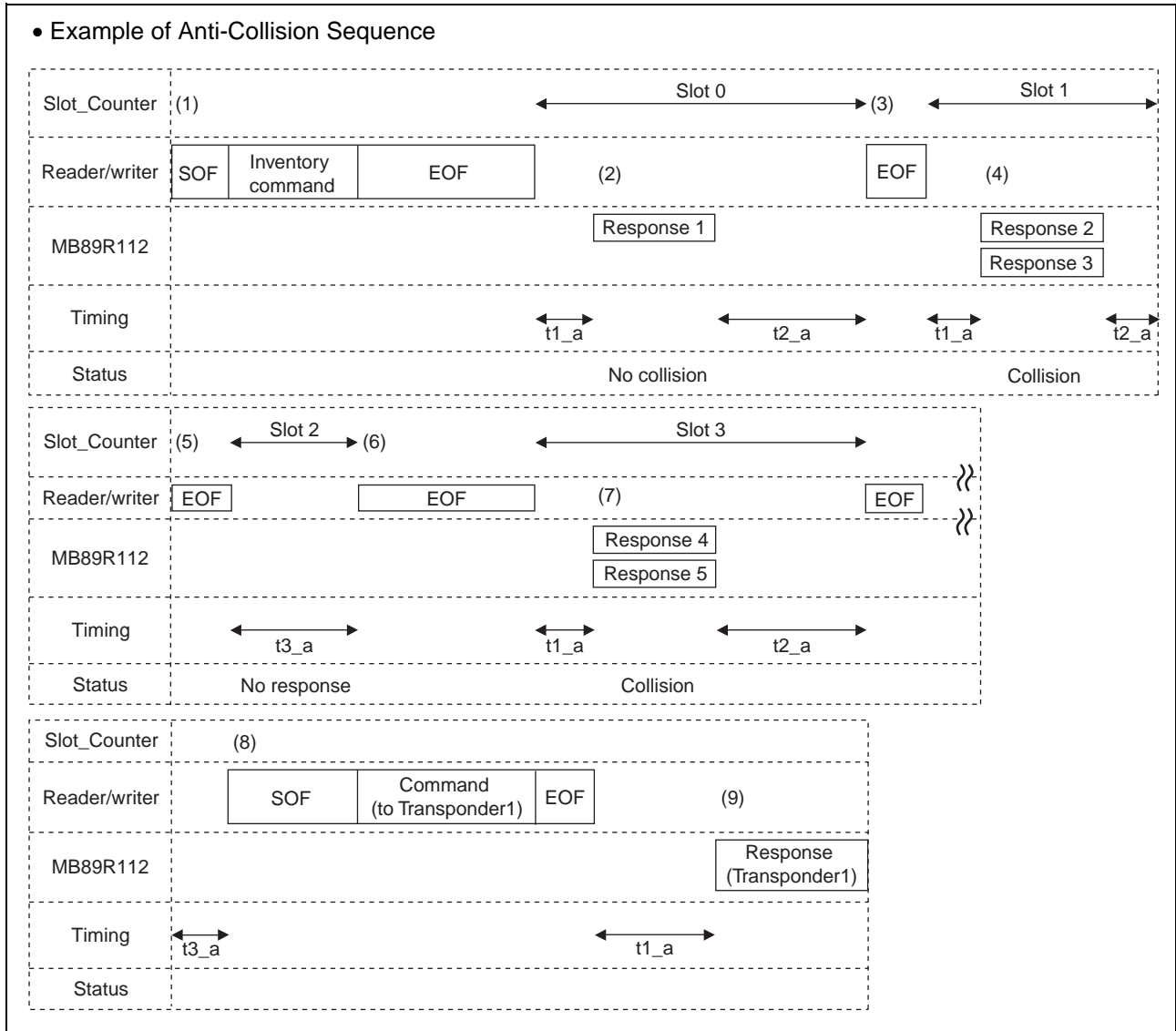

## 12. Timing definitions

### (1) Period during which the MB89R112 waits for the start of response transmission after an EOF signal transmitted from the reader/writer : t1\_a

After detection of an EOF signal sent from the reader/writer, MB89R112 must wait for a certain time (t1\_a) before sending a response to the reader/writer. t1\_a begins at the rising edge of the EOF pulse, and it is defined as follows. The minimum value is  $4320/fc$  (318.6  $\mu$ s), the nominal value is  $4352/fc$  (320.9  $\mu$ s), and the maximum value is  $4384/fc$  (323.3  $\mu$ s).

Even if the 10% ASK modulated signal from the reader/writer is detected within the time t1\_a, the transponder ignore the signal and wait for further time t1\_a before starting to transmit.

### (2) Period during which the MB89R112 ignores modulated signals after an EOF signal transmitted from the reader/writer : tmit

After detection of an EOF signal sent from the reader/writer, MB89R112 must ignore the 10% ASK modulated signals from the reader/writer for a time (tmit).

tmit begins at the rising edge of the EOF pulse. The minimum value of tmit is defined as  $4384/fc$  (323.3  $\mu$ s) + tnr.

In the above expression, tnr stands for the response time of MB89R112.

### (3) Period during which the reader/writer waits before sending a request : t2\_a

When the reader/writer has received a response from the transponder to a previous request other than Inventory and Stay Quiet command, it shall wait a time t2\_a before sending a subsequent request. The minimum value of t2\_a is 309.2  $\mu$ s. It is defined in ISO/IEC 15693-3. And ISO/IEC 18000-3 (Mode 1) .

### (4) Period during which the reader/writer waits before sending a request during execution of the Inventory command : t2inv

While an Inventory command is being executed, the reader/writer sends an EOF signal when it shifts to the next slot. In this case, the wait time is defined as follows depending on whether transponders return responses :

#### - Wait time applied when the reader/writer has received one or more responses : t2invwr

It is defined in ISO/IEC 15693-3. And ISO/IEC 18000-3 (Mode 1) that when the reader/writer has received one or more responses, the reader/writer must wait until responses from the transponders have been completed (that is, the reader/writer receives an EOF signal or tnr passes). After that, the reader/writer must wait until t2\_a passes before sending an EOF signal to switch to the next slot.

#### - Wait time applied when the reader/writer has not received any responses : t3\_a

When the reader/writer has not received any responses from the MB89R112, the reader/writer must wait until t3\_a passes before sending an EOF signal. In this case, t3\_a begins at the rising edge of the EOF pulse that was sent previously. The minimum value of t3\_a is defined as shown in the following table.

MB89R112 does not support the minimum value of t3\_a as " $4384/fc$  (323.3  $\mu$ s) + tsof" when the reader/writer sends a 100% modulated EOF, which is defined in ISO/IEC 15693-3 and ISO/IEC 18000-3 (Mode 1).

(a) If the reader/writer sends a ASK10% modulated EOF, the minimum value of t3\_a (ASK10%) is " $4384/fc$  (323.3  $\mu$ s + tnr)"

(b) If the reader/writer sends a ASK100% modulated EOF, the minimum value of t3\_a (ASK100%) is " $4384/fc$  (323.3  $\mu$ s + tsof)"

tnr: The nominal response time of transponder

tsof: The time for transponder to transmit a SOF to the reader/writer

# MB89R112

• t3\_a for ASK10% and ASK100% signal

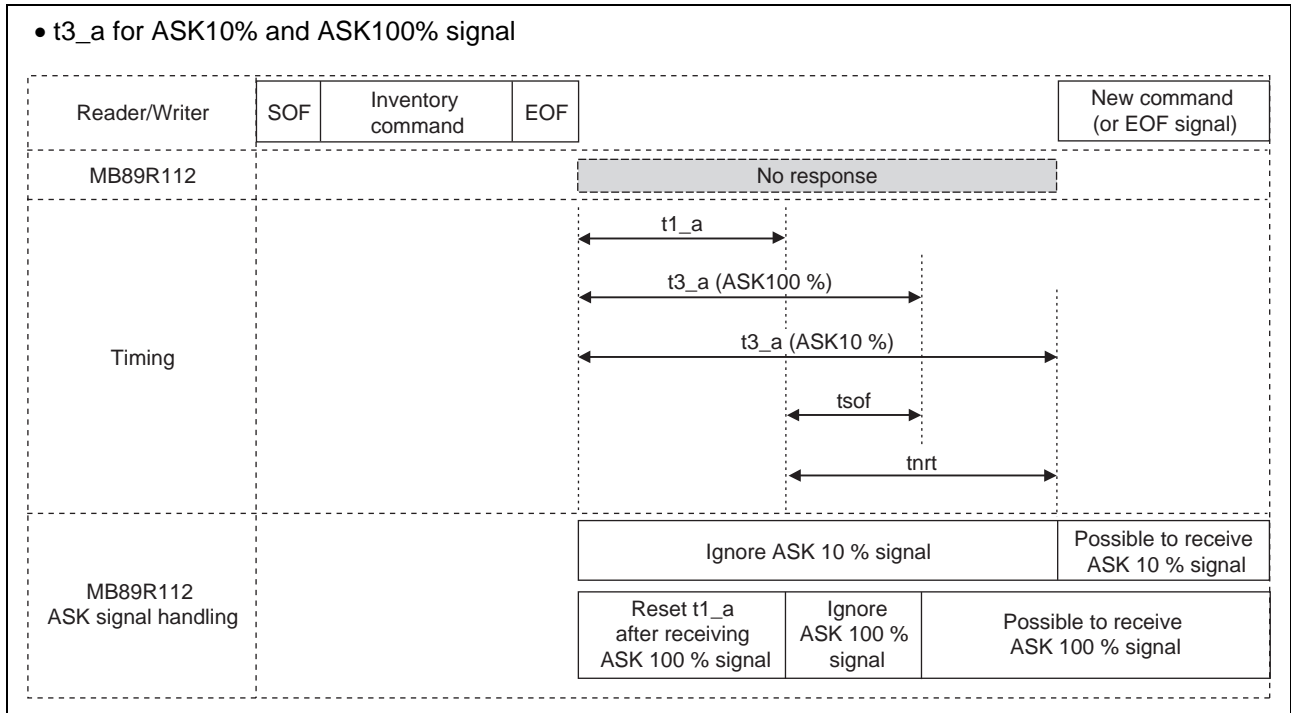

• Timing specification

	Min	Typ	Max
t1_a	4320/fc (318.6 μs)	4352/fc (320.9 μs)	4384/fc (323.3 μs)
tmit	4384/fc (323.3 μs) + tnrt	—	—
t2_a	4192/fc (309.2 μs)	—	—
t2invwr	t2_a + tnrt	—	—
t3_a (ASK10%)	4384/fc (323.3 μs) + tnrt	—	—
t3_a (ASK100%)	4384/fc (323.3 μs) + tsof	—	—
tnrt	—	Low data rate : 15708.16 ms High data rate : 3927.04 ms Fast Low data rate : 7854.08 ms Fast High data rate : 1963.52 ms	—
tsof	—	Low data rate : 604.16 ms High data rate : 151.04 ms Fast Low data rate : 302.08 ms Fast High data rate : 75.52 ms	—

## ■ COMMANDS OF RF COMMUNICATION MODE

The following Mandatory and Optional commands defined by ISO/IEC 15693-3 are supported. (partly not supported: Please refer to ■ USAGE NOTES for details).

The following Custom commands are supported :

- Fast command : Respond at double speed compared to ISO commands

### • Command list

Command code	Command name	Command Type	Details
"01 <sub>H</sub> "	Inventory	Mandatory	Execute the Anti-collision sequence and get UID.
"02 <sub>H</sub> "	Stay Quiet	Mandatory	Enter the Quiet state.
"20 <sub>H</sub> "	Read Single Block	Optional	Read the requested 1 block data in the user area/system area.
"21 <sub>H</sub> "	Write Single Block	Optional	Write the requested 1 block data in the user area.
"22 <sub>H</sub> "	Lock Block	Optional	Lock (disable to write) the requested 1 block in the user area.
"23 <sub>H</sub> "	Read Multiple Blocks	Optional	Read the requested successive blocks data in the user area/system area (Up to 256 blocks).
"25 <sub>H</sub> "	Select	Optional	Enter the select (communication selected) state.
"26 <sub>H</sub> "	Reset to Ready	Optional	Enter the ready (communication enabled) state.
"27 <sub>H</sub> "	Write AFI	Optional	Write AFI (Application Family Identifier) data.
"28 <sub>H</sub> "	Lock AFI	Optional	Lock AFI data (disable to write).
"29 <sub>H</sub> "	Write DSFID	Optional	Write DSFID (Data Storage Format Identifier) data.
"2A <sub>H</sub> "	Lock DSFID	Optional	Lock DSFID (Data Storage Format Identifier) data (disable to write).
"2B <sub>H</sub> "	Get System Information	Optional	Read the system information value (UID, DSFID, AFI, number of bytes per block, number of blocks in user area, and IC information).
"2C <sub>H</sub> "	Get Multiple Block Security Status	Optional	Read the block security status stored in system area.
"B1 <sub>H</sub> "	Fast Inventory	Custom	Fast response Inventory command.
"BC <sub>H</sub> "	Refresh System Blocks	Custom	Write "00 <sub>H</sub> " into the requested block in the user area/system area.
"C0 <sub>H</sub> "	Fast Read Single Block	Custom	Fast response Read Single Block command.
"C1 <sub>H</sub> "	Fast Write Single Block	Custom	Fast response Write Single Block command.
"C3 <sub>H</sub> "	Fast Read Multiple Blocks	Custom	Fast response Read Multiple Blocks command.
"D9 <sub>H</sub> "	Read Lock Block	Custom	Lock (disable to write) the requested 1 block in the user area.
"DA <sub>H</sub> "	Get Multiple Read Lock status	Custom	Read the read Lock status stored in the system area.

## 1. Description of Mandatory Commands

### 1-1. Inventory command

The Inventory command executes the anti-collision sequence.

If an error is detected during execution of this command, a response indicating the error shall not be returned.

The Inventory\_flag (bit 3) must be set to "1".

When the AFI\_flag (bit 5) in the Inventory command frame is set as "1", the response shall be returned in the following cases.

- The AFI value of the transponder is in accord with the optional AFI value.
- The 4 bits value MSB of the Optional AFI is "0H", and the 4 bits value LSB of the Optional AFI is in accord with the 4 bits value LSB of the transponder.
- The 4 bits value LSB of the Optional AFI is "0H", and the 4 bits value MSB of the Optional AFI is in accord with the 4 bits value MSB of the transponder.
- The optional AFI value is "00H".

#### • Request

[Request from the reader/writer to the transponder]

SOF	Flag	Command (Inventory)	Optional AFI	Mask length	Mask value	CRC	EOF
	8 bits	8 bits ("01H")	8 bits	8 bits	0 to 64 bits	16 bits	

#### • Response

[Response from the transponder to the reader/writer]

SOF	Flag	DSFID	UID	CRC	EOF
	8 bits ("00H")	8 bits	64 bits	16 bits	

### 1-2. Stay Quiet command

On receiving the Stay Quiet command, the transponder enters the quiet state. The transponder does not return any responses, including an error indication.

In the quiet state, the transponder does not execute any request for which the Inventory\_flag (bit 3) is set to "1" and executes only a command for which the Address\_flag (bit 6) is set to "1".

The transponder exits the quiet state only in the following cases:

- The transponder enters the power-off state.
- The transponder receives the Select command and enters the select state.
- The transponder receives the Reset to Ready command and enters the ready state.

#### • Request

[Request from the reader/writer to the transponder]

SOF	Flag	Command (Stay Quiet)	UID (necessary)	CRC	EOF
	8 bits	8 bits ("02H")	64 bits	16 bits	

#### • Response

[Response from the transponder to the reader/writer]

No response

## 2. Description of Optional Commands

### 2-1. Read Single Block command

On receiving the Read Single Block command, the transponder reads the data stored in the specified single block to the reader/writer.

If the Option\_flag (bit 7) is "1", the transponder adds block security status information in the response. If the Option\_flag (bit 7) is "0", the transponder returns only the data in the specified block to the reader/writer.

- Request

[Request from the reader/writer to the transponder]

SOF	Flag	Command (Read Single Block)	UID (Addressed mode)	Number of blocks	CRC	EOF
	8 bits	8 bits ("20H")	64 bits	8 bits	16 bits	

- Response

[Response from the transponder to the reader/writer]

(1) When Error\_flag set

SOF	Flag	Error code	CRC	EOF
	8 bits ("01H")	8 bits	16 bits	

(2) When Error\_flag not set

SOF	Flag	Block security status (option)	Data	CRC	EOF
	8 bits ("00H")	8 bits	256 bits	16 bits	

### 2-2. Write Single Block command

On receiving the Write Single Block command, the transponder writes the single block data included in the request to the specified block.

The transponder performs verification after writing and returns an error code if the writing has failed.

If the Option\_flag (bit 7) is "0", the transponder shall return its response when it has completed the write operation starting after " $t_{1nom}$  (320.9  $\mu$ s) + a multiple of 4096/fc (302.1  $\mu$ s)" with total tolerance of  $\pm 32/fc$  (2.4  $\mu$ s) and latest within 20 ms. If it is "1", transponder shall wait for the reception of an EOF from the reader/writer and upon such reception still return its response (However, if an EOF is not sent within 38 ms, the time-out occurs and the transponder can receive another command).

- Request

[Request from the reader/writer to the transponder]

SOF	Flag	Command (Write Single Block)	UID (Addressed mode)	Number of blocks	Data	CRC	EOF
	8 bits	8 bits ("21H")	64 bits	8 bits	256 bits	16 bits	

- Response

[Response from the transponder to the reader/writer]

(1) When Error\_flag set

SOF	Flag	Error code	CRC	EOF
	8 bits ("01 <sub>H</sub> ")	8 bits	16 bits	

(2) When Error\_flag not set

SOF	Flag	CRC	EOF
	8 bits ("00 <sub>H</sub> ")	16 bits	

## 2-3. Lock Block command

On receiving the Lock Block command, the transponder locks (write disable) permanently the data stored in one specified single block.

The transponder performs verification after writing and returns an error code if the writing has failed.

If the Option\_flag (bit 7) is "0", the transponder shall return its response when it has completed the lock operation starting after "t1nom (320.9 μs) + a multiple of 4096/fc (302.1 μs)" with total tolerance of ± 32/fc (2.4 μs) and latest within 20 ms. If it is "1", transponder shall wait for the reception of an EOF from the reader/writer and upon such reception still return its response. (However, if an EOF is not sent within 38 ms, the time-out occurs and the transponder can receive another command.)

Once the Lock Block command has been received, data in the locked block cannot be changed by any command.

- Request

[Request from the reader/writer to the transponder]

SOF	Flag	Command (Lock Block)	UID (Addressed mode)	Number of blocks	CRC	EOF
	8 bits	8 bits ("22 <sub>H</sub> ")	64 bits	8 bits	16 bits	

- Response

[Response from the transponder to the reader/writer]

(1) When Error\_flag set

SOF	Flag	Error code	CRC	EOF
	8 bits ("01 <sub>H</sub> ")	8 bits	16 bits	

(2) When Error\_flag not set

SOF	Flag	CRC	EOF
	8 bits ("00 <sub>H</sub> ")	16 bits	



## 2-4. Read Multiple Blocks Command

On receiving the Read Multiple Blocks command, the transponder reads the data stored in the specified successive blocks to the reader/writer.

If the Option\_flag (bit 7) is "1", the transponder adds block security status information in the response. If the Option\_flag (bit 7) is "0", the transponder returns only the data in the specified blocks to the reader/writer. The value of the "number of blocks" field specified in the request is the expected number of blocks minus 1. Setting the number of blocks to "01<sub>H</sub>" makes a request to read 2 blocks. Setting the number of blocks to "00<sub>H</sub>" makes a request to read 1 block (the request having the same effect as the Read Single Block command).

- Request

[Request from the reader/writer to the transponder]

SOF	Flag	Command (Read Multiple Blocks)	UID (Addressed mode)	First block number	Number of blocks	CRC	EOF
	8 bits	8 bits ("23 <sub>H</sub> ")	64 bits	8 bits	8 bits	16 bits	

- Response

[Response from the transponder to the reader/writer]

(1) When Error\_flag set

SOF	Flag	Error code	CRC	EOF
	8 bits ("01 <sub>H</sub> ")	8 bits	16 bits	

(2) When Error\_flag not set

SOF	Flag	Block security status (option)	Data	CRC	EOF
	8 bits ("00 <sub>H</sub> ")	8 bits	256 bits	16 bits	
Repeated as required					

## 2-5. Select command

Of the transponders that received the Select command, only the transponder whose UID matches the UID included in the request enters the select state and returns a response.

The other transponders, whose UIDs do not match the UID in the request, enter the ready state without returning any response. The Select command is used only in Addressed mode.

- Request

[Request from the reader/writer to the transponder]

SOF	Flag	Command (Select)	UID (necessary)	CRC	EOF
	8 bits	8 bits ("25H")	64 bits	16 bits	

- Response

[Response from the transponder to the reader/writer]

(1) When Error\_flag set

SOF	Flag	Error code	CRC	EOF
	8 bits ("01H")	8 bits	16 bits	

(2) When Error\_flag not set

SOF	Flag	CRC	EOF
	8 bits ("00H")	16 bits	

## 2-6. Reset to Ready command

On receiving the Reset to Ready command, the transponder enters the ready state.

- Request

[Request from the reader/writer to the transponder]

SOF	Flag	Command (Reset to Ready)	UID (Addressed mode)	CRC	EOF
	8 bits	8 bits ("26H")	64 bits	16 bits	

- Response

[Response from the transponder to the reader/writer]

(1) When Error\_flag set

SOF	Flag	Error code	CRC	EOF
	8 bits ("01H")	8 bits	16 bits	

(2) When Error\_flag not set

SOF	Flag	CRC	EOF
	8 bits ("00H")	16 bits	

## 2-7. Write AFI command

On receiving the Write AFI command, the transponder writes the data of AFI to FRAM.

The transponder performs verification after writing and returns an error code if the writing has failed.

If the Option\_flag (bit 7) is "0", the transponder shall return its response when it has completed the write operation starting after " $t_{1nom}$  (320.9  $\mu$ s) + a multiple of 4096/fc (302.1  $\mu$ s)" with total tolerance of  $\pm 32/fc$  (2.4  $\mu$ s) and latest within 20 ms. If it is "1", transponder shall wait for the reception of an EOF from the reader/writer and upon such reception still return its response (However, if an EOF is not sent within 38 ms, the time-out occurs and the transponder can receive another command) .

- Request

[Request from the reader/writer to the transponder]

SOF	Flag	Command (Write AFI)	UID (Addressed mode)	AFI	CRC	EOF
	8 bits	8 bits ("27H")	64 bits	8 bits	16 bits	

- Response

[Response from the transponder to the reader/writer]

(1) When Error\_flag set

SOF	Flag	Error code	CRC	EOF
	8 bits ("01H")	8 bits	16 bits	

(2) When Error\_flag not set

SOF	Flag	CRC	EOF
	8 bits ("00H")	16 bits	

## 2-8. Lock AFI command

On receiving the Lock AFI command, the transponder locks (write disable) permanently the data of AFI.

The transponder performs verification after writing and returns an error code if the writing has failed.

If the Option\_flag (bit 7) is "0", the transponder shall return its response when it has completed the lock operation starting after " $t_{1nom}$  (320.9  $\mu$ s) + a multiple of 4096/fc (302.1  $\mu$ s)" with total tolerance of  $\pm 32/fc$  (2.4  $\mu$ s) and latest within 20 ms. If it is "1", transponder shall wait for the reception of an EOF from the reader/writer and upon such reception still return its response (However, if an EOF is not sent within 38 ms, the time-out occurs and the transponder can receive another command) .

Once the Lock AFI command has been received, the data of AFI cannot be changed by the any command.

- Request

[Request from the reader/writer to the transponder]

SOF	Flag	Command (Lock AFI)	UID (Addressed mode)	CRC	EOF
	8 bits	8 bits ("28H")	64 bits	16 bits	

- Response

[Response from the transponder to the reader/writer]

(1) When Error\_flag set

SOF	Flag	Error code	CRC	EOF
	8 bits ("01H")	8 bits	16 bits	

(2) When Error\_flag not set

SOF	Flag	CRC	EOF
	8 bits ("00H")	16 bits	

## 2-9. Write DSFID command

On receiving the Write DSFID command, the transponder writes the data of DSFID to FRAM.

The transponder performs verification after writing and returns an error code if the writing has failed.

If the Option\_flag (bit 7) is "0", the transponder shall return its response when it has completed the write operation starting after " $t_{1nom}$  (320.9  $\mu$ s) + a multiple of  $4096/f_c$  (302.1  $\mu$ s)" with total tolerance of  $\pm 32/f_c$  (2.4  $\mu$ s) and latest within 20 ms. If it is "1", transponder shall wait for the reception of an EOF from the reader/writer and upon such reception still return its response (However, if an EOF is not sent within 38 ms, the time-out occurs and the transponder can receive another command) .

- Request

[Request from the reader/writer to the transponder]

SOF	Flag	Command (Write DSFID)	UID (Addressed mode)	DSFID	CRC	EOF
	8 bits	8 bits ("29H")	64 bits	8 bits	16 bits	

- Response

[Response from the transponder to the reader/writer]

(1) When Error\_flag set

SOF	Flag	Error code	CRC	EOF
	8 bits ("01H")	8 bits	16 bits	

(2) When Error\_flag not set

SOF	Flag	CRC	EOF
	8 bits ("00H")	16 bits	

## 2-10. Lock DSFID command

On receiving the Lock DSFID command, the transponder locks (write disable) permanently the data of DSFID.

The transponder performs verification after writing and returns an error code if the writing has failed.

If the Option\_flag (bit 7) is "0", the transponder shall return its response when it has completed the lock operation starting after " $t_{1nom}$  (320.9  $\mu$ s) + a multiple of 4096/fc (302.1  $\mu$ s)" with total tolerance of  $\pm 32/fc$  (2.4  $\mu$ s) and latest within 20 ms. If it is "1", transponder shall wait for the reception of an EOF from the reader/writer and upon such reception still return its response (However, if an EOF is not sent within 38 ms, the time-out occurs and the transponder can receive another command) .

Once the Lock DSFID command has been received, the data of DSFID cannot be changed by any command.

- Request

[Request from the reader/writer to the transponder]

SOF	Flag	Command (Lock DSFID)	UID (Addressed mode)	CRC	EOF
	8 bits	8 bits ("2A <sub>H</sub> ")	64 bits	16 bits	

- Response

[Response from the transponder to the reader/writer]

(1) When Error\_flag set

SOF	Flag	Error code	CRC	EOF
	8 bits ("01 <sub>H</sub> ")	8 bits	16 bits	

(2) When Error\_flag not set

SOF	Flag	CRC	EOF
	8 bits ("00 <sub>H</sub> ")	16 bits	

## 2-11. Get System Information command

On receiving the Get System Information command, the transponder reads the chip information of UID, AFI, DSFID, and so on to the reader/writer as a response.

- Request

[Request from the reader/writer to the transponder]

SOF	Flag	Command (Get System Information)	UID (Addressed mode)	CRC	EOF
	8 bits	8 bits ("2BH")	64 bits	16 bits	

- Response

[Response from the transponder to the reader/writer]

(1) When Error\_flag set

SOF	Flag	Error code	CRC	EOF
	8 bits ("01H")	8 bits	16 bits	

(2) When Error\_flag not set

SOF	Flag	Information flag	UID	DSFID	AFI	Memory size	IC reference	CRC	EOF
	8 bits ("00H")	8 bits	64 bits	8 bits	8 bits	16 bits	8 bits	16 bits	

The followings show the definitions of the Information flag and the memory size information (transponder memory size information) included in the response of the Get System Information command. However, the size of blocks and number of blocks in the user area shown in the memory size information about a transponder indicate one less than the actual value.

- Definition of information flag

Bit	Flag name	State	Description
1	DSFID	0	DSFID does not exist.
		1	DSFID is supported.
2	AFI	0	AFI does not exist.
		1	AFI is supported.
3	Memory size	0	Memory size information does not exist.
		1	Memory size information is supported.
4	IC reference	0	IC reference information does not exist.
		1	IC reference information is supported.
5	RFU*	—	Set to "0"
6	RFU*	—	
7	RFU*	—	
8	RFU*	—	

\* : Reserved for future use

Note : For MB89R112, set "0FH" (set "1" for bit 1 to bit 4 and set "0" for bit 5 to bit 8) .

- Memory size information about a transponder

MSB			LSB		
16	14	13	9	8	1
RFU*		Size of blocks (Number of bytes in 1 block)		Number of blocks in the user area	

\* : Reserved for future use

Note : The memory size of the MB89R112 which consists of 256 blocks (32 bytes per block) in the user area, the memory size information is hexadecimal "1FFF<sub>H</sub>".

## 2-12. Get Multiple Block Security Status Command

On receiving the Get Multiple Block Security Status command, the transponder reads the block security status stored in a system area to the reader/writer as a response.

Up to 256 blocks of data can be read for one request. The number of blocks specified in this request must be the value that is 1 block less than the actual number of the blocks whose security status is to be obtained.

The first block number specified in this request must be a multiple of 8.

- Request

[Request from the reader/writer to the transponder]

SOF	Flag	Command (Get Multiple Block Security Status)	UID (Addressed mode)	First block number	Number of blocks	CRC	EOF
	8 bits	8 bits ("2C <sub>H</sub> ")	64 bits	8 bits	8 bits	16 bits	

- Response

[Response from the transponder to the reader/writer]

(1) When Error\_flag set

SOF	Flag	Error code	CRC	EOF
	8 bits ("01 <sub>H</sub> ")	8 bits	16 bits	

(2) When Error\_flag not set

SOF	Flag	Block security status	CRC	EOF
	8 bits ("00 <sub>H</sub> ")	8 bits (repeated as required)	16 bits	



### 3. Description of Custom Command

The IC manufacturing code is required to use a Custom command. The IC manufacturing code for the MB89R112 is "08<sub>H</sub>".

#### 3-1. Fast Inventory Command

The Fast Inventory command is the same as the Inventory Command that executes the anti-collision sequence.

The data rate in the response is twice as defined in ISO/IEC 15693.

If error is detected during execution of this command, a response indicating the error shall not be returned.

The Inventory\_flag (bit 3) must be set to "1".

When the AFI\_flag (bit 5) in the Inventory command frame is set as "1", the response shall be returned in the following cases.

- The AFI value of the transponder is in accord with the optional AFI value.
- The 4 bits value MSB of the Optional AFI is "0<sub>H</sub>", and the 4 bits value LSB of the Optional AFI is in accord with the 4 bits value LSB of the transponder.
- The 4 bits value LSB of the Optional AFI is "0<sub>H</sub>", and the 4 bits value MSB of the Optional AFI is in accord with the 4 bits value MSB of the transponder.
- The optional AFI value is "00<sub>H</sub>".

#### • Request

[Request from the reader/writer to the transponder]

SOF	Flag	Command (Fast Inventory)	IC manufacturer code (necessary)	Optional AFI	Mask length	Mask value	CRC	EOF
	8 bits	8 bits ("B1 <sub>H</sub> ")	8 bits ("08 <sub>H</sub> ")	8 bits	8 bits	0 to 64 bits	16 bits	

#### • Response

[Response from the transponder to the reader/writer]

SOF	Flag	DSFID	UID	CRC	EOF
	8 bits ("00 <sub>H</sub> ")	8 bits	64 bits	16 bits	

## 3-2. Refresh System Blocks Command

The Refresh System Blocks command write "00H" into the requested area of FRAM.

When the requested area is in the system area, "00H" shall be written into excepting UID area.

If the requested area is user area , there is no limitation to execute the Refresh System Blocks command. However if the requested area is system area, the Refresh System Blocks command can be executed only once.

If the Option\_flag (bit 7) is "0", the transponder shall return its response when it has completed the lock operation starting after "t1nom (320.9 μs) + a multiple of 4096/fc (302.1 μs)" with total tolerance of  $\pm 32/fc$  (2.4 μs) and latest within 20 ms. If it is "1", the transponder shall wait for the reception of an EOF from the reader/writer, and upon such reception still return its response. (However, if an EOF is not sent within 38 ms, the time-out occurs and the transponder can receive another command. )

Bank Number	The Block for Refresh
00H	User area 00H to 3FH
01H	User area 40H to 7FH
02H	User area 80H to BFH
03H	User area C0H to FFH
FFH	System area (The UID area is excluded.)
Except the above	Prohibition of a setup (A 10H error reply is returned. )

- Request

[Request from the reader/writer to the transponder]

SOF	Flag	Command (Refresh System Blocks)	IC manufacturer code	UID (Addressed mode)	Bank Number	CRC	EOF
	8 bits	8 bits ("BCH")	8 bits ("08H")	64 bits	8 bits	16 bits	

- Response

[Response from the transponder to the reader/writer]

(1) When Error\_flag set

SOF	Flag	Error code	CRC	EOF
	8 bits ("01H")	8 bits	16 bits	

(2) When Error\_flag not set

SOF	Flag	CRC	EOF
	8 bits ("00H")	16 bits	

### 3-3. Fast Read Single Block Command

The Fast Read Single Block command is the same as the Read Single Block command that reads the data stored in the specific single block. The data rate in the response is twice as defined in ISO/IEC 15693.

If the Option\_flag (bit 7) is "1", the transponder adds block security status information in the response. If the Option\_flag (bit 7) is "0", the transponder returns only the data in the specified block to the reader/writer.

- Request

[Request from the reader/writer to the transponder]

SOF	Flag	Command (Fast Read Single Block)	IC manufacturer code (necessary)	UID (Addressed mode)	Block number	CRC	EOF
	8 bits	8 bits ("C0H")	8 bits ("08H")	64 bits	8 bits	16 bits	

- Response

[Response from the transponder to the reader/writer]

(1) When Error\_flag set

SOF	Flag	Error code	CRC	EOF
	8 bits ("01H")	8 bits	16 bits	

(2) When Error\_flag not set

SOF	Flag	Block security status(option)	Data	CRC	EOF
	8 bits ("00H")	8 bits	256 bits	16 bits	

### 3-4. Fast Write Single Block Command

The Fast Write Single Block command is the same as the Write Single Block command that writes the single block data included in the request. The data rate in the response is twice as defined in ISO/IEC 15693.

The transponder performs verification after writing and returns an error code if the writing has failed.

If the Option\_flag (bit 7) is "0", the transponder shall return its response when it has completed the write operation starting after "t1nom (320.9 μs) + a multiple of 4096/fc (302.1 μs)" with total tolerance of ±32/fc (2.4 μs) and latest within 20 ms. If it is "1", transponder shall wait for the reception of an EOF from the reader/writer and upon such reception still return its response (However, if an EOF is not sent within 38 ms, the time-out occurs and the transponder can receive another command) .

- Request

[Request from the reader/writer to the transponder]

SOF	Flag	Command (Fast Write Single Block)	IC manufacturer code (necessary)	UID (Addressed mode)	Block number	Data	CRC	EOF
	8 bits	8 bits ("C1H")	8 bits ("08H")	64 bits	8 bits	256 bits	16 bits	

- Response

[Response from the transponder to the reader/writer]

(1) When Error\_flag set

SOF	Flag	Error code	CRC	EOF
	8 bits ("01H")	8 bits	16 bits	

(2) When Error\_flag not set

SOF	Flag	CRC	EOF
	8 bits ("00H")	16 bits	

## 3-5. Fast Read Multiple Blocks Command

The Fast Read Multiple Blocks command is the same as the Read Multiple Blocks command that reads the data of the specified successive blocks.

Up to 256 blocks of data can be read for one request. The data rate in the response is twice as defined in ISO/IEC 15693.

If the Option\_flag (bit 7) is "1", the transponder adds block security status information in the response. If the Option\_flag (bit 7) is "0", the transponder returns only the data in the specified blocks to the reader/writer. The value of the "number of blocks" field specified in the request is the expected number of blocks minus 1. Setting the number of blocks to "01<sub>H</sub>" makes a request to read 2 blocks. Setting the number of blocks to "00<sub>H</sub>" makes a request to read 1 block (the request having the same effect as the Fast Read Single Block command).

- Request

[Request from the reader/writer to the transponder]

SOF	Flag	Command (Fast Read Multiple Blocks)	IC manufacturer code (necessary)	UID (Addressed mode)	First block number	Number of blocks	CRC	EOF
	8 bits	8 bits ("C3 <sub>H</sub> ")	8 bits ("08 <sub>H</sub> ")	64 bits	8 bits	8 bits	16 bits	

- Response

[Response from the transponder to the reader/writer]

(1) When Error\_flag set

SOF	Flag	Error code	CRC	EOF
	8 bits ("01 <sub>H</sub> ")	8 bits	16 bits	

(2) When Error\_flag not set

SOF	Flag	Block security status(option)	Data	CRC	EOF
	8 bits ("00 <sub>H</sub> ")	8 bits	256 bits	16 bits	
Repeated as required					

## 3-6. Read Lock Block Command

On receiving the Read Lock Block command, the transponder locks (read disable) permanently the data stored in one specified single-block. The transponder performs verification after writing and returns an error code if the writing has failed.

If the Option\_flag (bit 7) is "0", the transponder shall return its response when it has completed the lock operation starting after " $t_{1nom}$  (320.9  $\mu$ s) + a multiple of  $4096/f_c$  (302.1  $\mu$ s)" with total tolerance of  $\pm 32/f_c$  (2.4  $\mu$ s) and latest within 20 ms. If it is "1", the transponder shall wait for the reception of an EOF from the reader/writer, and upon such reception still return its response (However, if an EOF is not sent within 38 ms, the time-out occurs and the transponder can receive another command).

Once the Read Lock Block command has been received, data in the locked block cannot read by the Read Single Block command. On the other hand, if the locked block is accessed as part of the selected blocks by the Read Multiple Blocks command, the data of the locked block is indicated as "00H" among the batch of the data.

- Request

[Request from the reader/writer to the transponder]

SOF	Flag	Command (Read Lock Block)	IC manufacturer code	UID (Addressed mode)	Block number	CRC	EOF
	8 bits	8 bits ("D9H")	8 bits ("08H")	64 bits	8 bits	16 bits	

- Response

[Response from the transponder to the reader/writer]

(1) When Error\_flag set

SOF	Flag	Error code	CRC	EOF
	8 bits ("01H")	8 bits	16 bits	

(2) When Error\_flag not set

SOF	Flag	CRC	EOF
	8 bits ("00H")	16 bits	

## 3-7. Get Multiple Read Lock Status Command

On receiving the Get Multiple Read Lock Status command, the transponder reads the Read Lock status stored in the system area.

Up to 256 blocks of status can be read for one request. The number of blocks specified in this request must be the value that is 1 block less than the actual number of whose security status is to be obtained.

The first block number specified in this request must be a multiple of 8.

- Request

[Request from the reader/writer to the transponder]

SOF	Flag	Command (Get Multiple Read Lock Status)	IC manufacturer code	UID (Ad- dressed mode)	First block number	Number of blocks	CRC	EOF
	8 bits	8 bits ("DA <sub>H</sub> ")	8 bits ("08 <sub>H</sub> ")	64 bits	8 bits	8 bits	16 bits	

- Response

[Response from the transponder to the reader/writer]

(1) When Error\_flag set

SOF	Flag	Error code	CRC	EOF
	8 bits ("01 <sub>H</sub> ")	8 bits	16 bits	

(2) When Error\_flag not set

SOF	Flag	Read Lock Status	CRC	EOF
	8 bits	8 bits (repeated as required)	16 bits	

## 4. Command Execution Time

### 4-1. Write Single Block Command Execution Time

The minimum time (processing in the Addressed mode) required to complete data writing to all user areas (8192 bytes) of the FRAM and verification with the Write Single Block command is estimated to be 4.0 seconds.

### 4-2. Read Multiple Blocks Command Execution Time

The minimum time (processing in the Addressed mode) required to complete data reading for all user areas (8192 bytes) of the FRAM with the Read Multiple Blocks command is estimated to be 2.5 seconds. In addition, with the Fast Read Multiple Blocks command is estimated to be 1.3 seconds.

## ■ STATE TRANSITION DIAGRAM

- Definition of states for RF communication

Each state of MB89R112 is defined as follows.

- Power-off state : In the power-off state, a transponder cannot fulfill the function so that the voltage from a reader/writer is underpowered.
- Ready state : In the ready state, the MB89R112 can execute all commands if the Select\_flag is not set.
- Quiet state : In the quiet state, the MB89R112 can execute the command for which the Inventory\_flag is not set and the Address\_flag is set.
- Select state : In the select state, the MB89R112 can execute the command for which the Select\_flag is set.

As shown in figure below, the MB89R112 moves from one state to another according to the status of power and by a command.

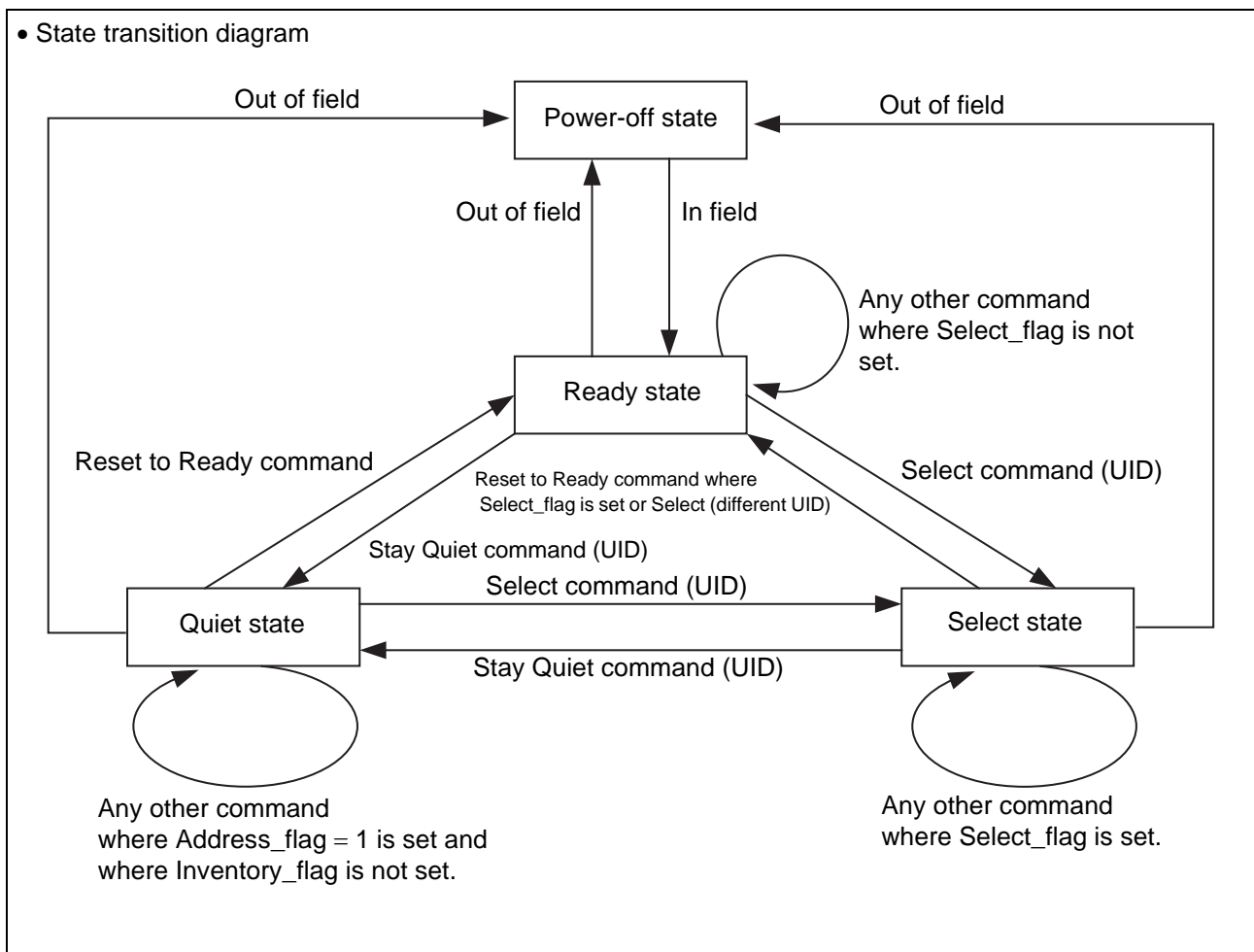



## ■ ABSOLUTE MAXIMUM RATINGS

Parameter	Symbol	Rating		Unit	Remarks
		Min	Max		
Maximum input voltage	$I_{max}$	—	90	mA <sub>P-P</sub>	Between PWRP-PWRM
Input voltage	$I_{RF}$	—	30	mA <sub>rms</sub>	Antenna connected.
ESD voltage immunity	$ V_{ESD} $	—	2	kV	Human Body Model
		—	200	V	Machine Model
Storage temperature	$T_{stg}$	- 55	+ 125	°C	Excluding FRAM data retention guarantee

WARNING: Semiconductor devices may be permanently damaged by application of stress (including, without limitation, voltage, current or temperature) in excess of absolute maximum ratings.  
Do not exceed any of these ratings.

## ■ RECOMMENDED OPERATING CONDITIONS

Parameter	Symbol	Value			Unit	Remarks
		Min	Typ	Max		
Minimum antenna input voltage	$V_{RF}$	—	7.5	10.2	$V_{P-P}$	Antenna connected.
ASK modulation index (10%)	m	10	—	30	%	
ASK modulation index (100%)	m	95	—	100	%	
ASK pulse width (10%)	t1	6.00	—	9.44	$\mu S$	
	t2	3.0	—	t1	$\mu S$	
	t3	0	—	4.5	$\mu S$	
ASK pulse width (100%)	t1	6.00	—	9.44	$\mu S$	
	t2	2.1	—	t1	$\mu S$	
	t3	1.0*	—	4.5	$\mu S$	
	t4	0	—	0.8	$\mu S$	
Input frequency	$F_{in}$	13.553	13.560	13.567	MHz	
Operating temperature	$T_a$	-20	—	+85	$^{\circ}C$	

\* : The minimum value of t3 on ASK100% does not meet ISO/IEC15693.

**WARNING:** The recommended operating conditions are required in order to ensure the normal operation of the semiconductor device. All of the device's electrical characteristics are warranted when the device is operated under these conditions.

Any use of semiconductor devices will be under their recommended operating condition. Operation under any conditions other than these conditions may adversely affect reliability of device and could result in device failure.

No warranty is made with respect to any use, operating conditions or combinations not represented on this data sheet. If you are considering application under any conditions other than listed herein, please contact sales representatives beforehand.

**Note:** However, because the communication characteristics is deeply related with the combination of antenna, reader/writer, and operating environment, this condition does not ensure the complete operation of transponders. Therefore it is recommended to confirm the communication characteristics with the actual antenna and reader/writer beforehand.

The values are confirmed with a reference antenna in the input capacitance 23 pF products, and its parameters are as follows.

External size : 75 mm × 46 mm  
 Number of turns : 6  
 Width of conductor : 1 mm  
 Space between 2 conductors : 0.4 mm

## ■ ELECTRICAL CHARACTERISTICS

Parameter	Symbol	Value			Unit	Remarks	
		Min	Typ	Max			
Load modulation resistance	R <sub>isw</sub>	—	1.1	—	kΩ		
Input capacitance*	23pF	C <sub>ant</sub>	21.85	23.00	24.15	pF	Voltage between antennas = 2 V <sub>rms</sub>
	96pF		86.4	96.0	105.6		

\* : The capacitance value is an alternative value, which is distinguished with the part number. The values are controlled by PCM (Process Control Monitor) in the wafer.

## ■ USAGE NOTES

### • Notes on the RF interface

- The performance of transponder is determined by not only LSI specification but also antenna design and reader/writer characteristics. Therefore it is recommended for the customers to optimize the antenna and reader/writer according to the required communication distance and usage environment.
- If the user intends to access multiple transponders from a reader/writer, the interference between transponders or between the reader/writer and a transponder may degrade communication performance (transmission distance and communication time). Therefore, a user who intends to design a system using multiple transponders should consider this point.

### • FRAM Characteristics

Item	Value		Unit	Parameter
	Min	Max		
Read/Write Endurance*1	10 <sup>12</sup>	—	Times/byte	Operation Ambient Temperature T <sub>A</sub> = + 85 °C
Data Retention*2	10	—	Years	Operation Ambient Temperature T <sub>A</sub> = + 85 °C
	30	—		Operation Ambient Temperature T <sub>A</sub> = + 70 °C*3

\*1 : Total number of reading and writing defines the minimum value of endurance, as an FRAM memory operates with destructive readout mechanism.

\*2 : Minimum values define retention time of the first reading/writing data right after shipment.

\*3 : This value is calculated by reliability test results for reference as well.

### • Differences of the function between ISO/IEC15693 and MB89R112.

The comparison of the function between ISO/IEC 15693 and MB89R112 is shown in the table below. MB89R112 does not support the following functions.

- 1 out of 256 data coding
- 2-subcarrier
- Write Multiple Blocks command

• MB89R112 functions compared with ISO/IEC15693

Parameter	ISO/IEC15693 specification	MB89R112
Modulation	10% ASK	Support
	100% ASK	Support*
Data coding	1 out of 256	Not support
	1 out of 4	Support
Subcarrier	1-subcarrier	Support
	2-subcarrier	Not support
Mandatory command	Inventory command	Support
	Stay Quiet command	Support
Optional command	Read Single Block command	Support
	Write Single Block command	Support
	Lock Block command	Support
	Read Multiple Blocks command	Support
	Write Multiple Blocks command	Not support
	Select command	Support
	Reset to Ready command	Support
	Write AFI command	Support
	Lock AFI command	Support
	Write DSFID command	Support
	Lock DSFID command	Support
	Get System Information command	Support
	Get Multiple Block Security Status command	Support

\* : The minimum value of t3 on ASK100% does not meet ISO/IEC15693. Refer to ■ RECOMMENDED OPERATING CONDITIONS.

## ■ RECOMMENDED ASSEMBLY CONDITIONS (WAFER)

The MB89R112 is recommended to be mounted in the following condition to maintain the data retention characteristics of the FRAM memory when the chip is mounted.

- Mounting temperature of +175 °C or lower, and 120 minutes or shorter when applied at high temperature, or
- Mounting temperature of +200 °C or lower, and 60 seconds or shorter when applied at high temperature

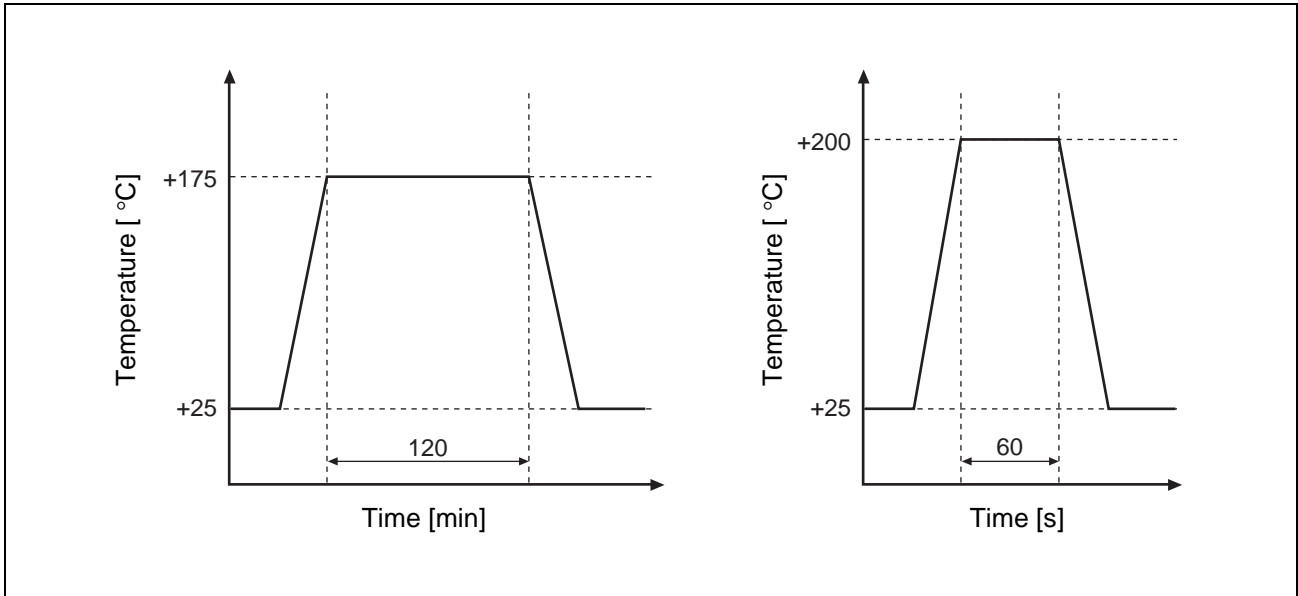

## ■ ORDERING INFORMATION

Part number	Input capacitance	Shipping method	Marking of Failed Chips
MB89R112A1-DIAP15-JN	23pF	Wafer (After dicing) with Frame Au Plating Bump Wafer thickness: 150 μm ± 25.4 μm	Wafer map
MB89R112A1-DIAP15-JNP1	23pF		Bad mark
MB89R112A2-DIAP15-JN	96pF		Wafer map
MB89R112A2-DIAP15-JNP1	96pF		Bad mark

## ■ MAJOR CHANGES IN THIS EDITION

A change on a page is indicated by a vertical line drawn on the left side of that page.

Page	Section	Change Results
1	■ FEATURES	Deleted description "Compliance with ISO/IEC 15693". Deleted trademark "FerVIDFamily" due to abandon of commercial right.
4	1. Unique Identifier (UID)	Deleted description "Complies with ISO/IEC 15693-3".
14	8. Anti-Collision Algorithm	Deleted description "Complies with ISO/IEC 15693-3" and rephrased.
42	■ RECOMMENDED OPERATING CONDITIONS	Amended and added description of t3.
45	• MB89R112 functions compared with ISO/IEC15693	added description of t3.



## FUJITSU SEMICONDUCTOR LIMITED

Shin-Yokohama Chuo Building, 2-100-45 Shin-Yokohama,  
Kohoku-ku, Yokohama, Kanagawa 222-0033, Japan  
<http://jp.fujitsu.com/fsl/en/>

### **All Rights Reserved.**

FUJITSU SEMICONDUCTOR LIMITED, its subsidiaries and affiliates (collectively, "FUJITSU SEMICONDUCTOR") reserves the right to make changes to the information contained in this document without notice. Please contact your FUJITSU SEMICONDUCTOR sales representatives before order of FUJITSU SEMICONDUCTOR device.

Information contained in this document, such as descriptions of function and application circuit examples is presented solely for reference to examples of operations and uses of FUJITSU SEMICONDUCTOR device. FUJITSU SEMICONDUCTOR disclaims any and all warranties of any kind, whether express or implied, related to such information, including, without limitation, quality, accuracy, performance, proper operation of the device or non-infringement. If you develop equipment or product incorporating the FUJITSU SEMICONDUCTOR device based on such information, you must assume any responsibility or liability arising out of or in connection with such information or any use thereof. FUJITSU SEMICONDUCTOR assumes no responsibility or liability for any damages whatsoever arising out of or in connection with such information or any use thereof.

Nothing contained in this document shall be construed as granting or conferring any right under any patents, copyrights, or any other intellectual property rights of FUJITSU SEMICONDUCTOR or any third party by license or otherwise, express or implied.

FUJITSU SEMICONDUCTOR assumes no responsibility or liability for any infringement of any intellectual property rights or other rights of third parties resulting from or in connection with the information contained herein or use thereof.

The products described in this document are designed, developed and manufactured as contemplated for general use including without limitation, ordinary industrial use, general office use, personal use, and household use, but are not designed, developed and manufactured as contemplated (1) for use accompanying fatal risks or dangers that, unless extremely high levels of safety is secured, could lead directly to death, personal injury, severe physical damage or other loss (including, without limitation, use in nuclear facility, aircraft flight control system, air traffic control system, mass transport control system, medical life support system and military application), or (2) for use requiring extremely high level of reliability (including, without limitation, submersible repeater and artificial satellite). FUJITSU SEMICONDUCTOR shall not be liable for you and/or any third party for any claims or damages arising out of or in connection with above-mentioned uses of the products.

Any semiconductor devices fail or malfunction with some probability. You are responsible for providing adequate designs and safeguards against injury, damage or loss from such failures or malfunctions, by incorporating safety design measures into your facility, equipments and products such as redundancy, fire protection, and prevention of overcurrent levels and other abnormal operating conditions.

The products and technical information described in this document are subject to the Foreign Exchange and Foreign Trade Control Law of Japan, and may be subject to export or import laws or regulations in U.S. or other countries. You are responsible for ensuring compliance with such laws and regulations relating to export or re-export of the products and technical information described herein.

All company names, brand names and trademarks herein are property of their respective owners.